

PAX2D

1/8 DIN Digital Input Panel Meter

Installation Guide



See the Red Lion website at www.redlion.net or the enclosed USB thumbdrive for a complete user manual

SPECIFICATIONS

POWER:

AC Power: 40 to 250 VAC, 50/60 Hz, 20 VA
 DC Power: 21.6 to 250 VDC, 8 W
 Isolation: 2300 Vrms for 1 min. to all inputs and outputs.

INPUTS A and B:

DIP switch selectable to accept pulses from a variety of sources including switch contacts, TTL outputs, magnetic pickups and all standard RLC sensors.

LOGIC: Input trigger levels $V_{IL} = 1.5$ V max.; $V_{IH} = 3.75$ V min.

Current sinking: Internal 7.8 K Ω pull-up to +5 VDC, $I_{MAX} = 0.7$ mA.

Current sourcing: Internal 3.9 K Ω pull-down, 7.3 mA max. @ 28 VDC, $V_{MAX} = 30$ VDC.

Filter: Damping capacitor provided for switch contact bounce. Limits input frequency to 50 Hz and input pulse widths to 10 msec. minimum.

MAGNETIC PICKUP:

Sensitivity: 200 mV peak

Hysteresis: 100 mV

Input impedance: 3.9 K Ω @ 60 Hz; Must also have SRC switch ON. (Not recommended with counting applications.)

Maximum input voltage: ± 40 V peak, 28 Vrms

DUAL COUNT MODES:

When any dual count mode is used, then User Inputs 1 and/or 2 will accept the second signal of each signal pair. The user inputs do not have the Logic/Mag, HI/LO Freq, and Sink/Source input setup switches. The user inputs are inherently a logic input with no low frequency filtering. Any mechanical contacts used for these inputs in a dual count mode must be debounced externally. The user input may only be selected for sink/source by the User Jumper placement.

SENSOR POWER:

± 18 VDC, $\pm 5\%$ @ 60 mA max.; short circuit protected

USER INPUTS:

Max. Continuous Input: 30 VDC

Isolation To Sensor Input Common: Not isolated.

PRESCALER OUTPUT:

NPN Open Collector: $I_{SNK} = 100$ mA max. @ $V_{OL} = 1$ VDC max. $V_{OH} = 30$ VDC max. Duty cycle 25% min. and 50 % max.

ENVIRONMENTAL CONDITIONS:

Operating Temperature Range: 0 to 50 °C

Storage Temperature Range: -40 to 60 °C

Vibration to IEC 68-2-6: Operational 5-150 Hz, 2 g

Shock to IEC 68-2-27: Operational 25 g (10 g relay)

Operating and Storage Humidity: 0 to 85% max. RH non-condensing

Altitude: Up to 2000 meters

CERTIFICATIONS AND COMPLIANCES:

CE Approved

EN 61326-1 Immunity to Industrial Locations

Emission CISPR 11 Class A

IEC/EN 61010-1

RoHS Compliant

UL Listed: File #E179259

Type 4X Indoor Enclosure rating (Face only)

IP65 Enclosure rating (Face only)

IP20 Enclosure rating (Rear of unit)

CONNECTIONS:

High compression cage-clamp terminal block

Wire Strip Length: 0.3" (7.5 mm)

Wire Gauge Capacity: One 14 AWG (2.55 mm) solid,

two 18 AWG (1.02 mm) or four 20 AWG (0.61 mm)

CONSTRUCTION:

This unit is rated NEMA 4X/IP65 for indoor use only.

IP20 Touch safe. Installation Category II, Pollution Degree 2. One piece bezel/ case. Flame resistant. Synthetic rubber keypad. Panel gasket and mounting clip included.

WEIGHT: 8 oz. (226.8 g)

DIMENSIONS In inches (mm)

Note: Recommended minimum clearance (behind the panel) for mounting clip installation is 2.1" (53.4) H x 5.5" (140) W.

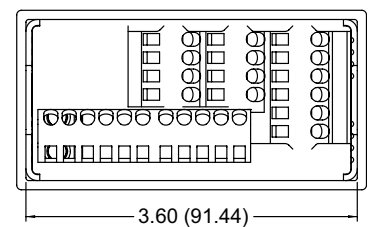
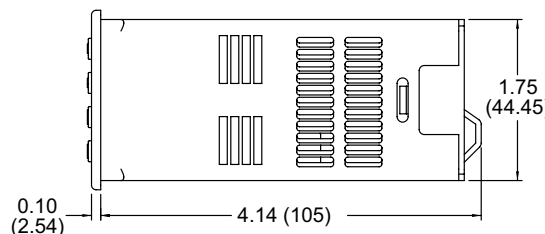
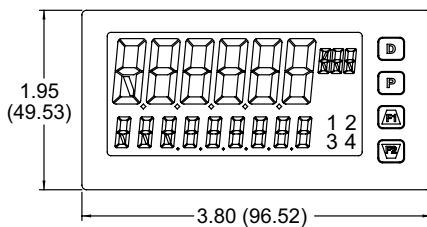

SAFETY SUMMARY

All safety related regulations, local codes and instructions that appear in this literature or on equipment must be observed to ensure personal safety and to prevent damage to either the instrument or equipment connected to it. If equipment is used in a manner not specified by the manufacturer, the protection provided by the equipment may be impaired. Do not use this unit to directly command motors, valves, or other actuators not equipped with safeguards. To do so can be potentially harmful to persons or equipment in the event of a fault to the unit.



CAUTION: Risk of Danger.
Read complete instructions prior to installation and operation of the unit.



CAUTION:
Risk of electric shock.

METER INSTALLATION

The PAX2D meets NEMA 4X/IP65 requirements when properly installed. The unit is intended to be mounted into an enclosed panel. Prepare the panel cutout to the dimensions shown. Remove the panel latch from the unit. Slide the panel gasket over the rear of the unit to the back of the bezel. The unit should be installed fully assembled. Insert the unit into the panel cutout.

While holding the unit in place, push the panel latch over the rear of the unit so that the tabs of the panel latch engage in the slots on the case. The panel latch should be engaged in the farthest forward slot possible. To achieve a proper seal, tighten the latch screws evenly until the unit is snug in the panel (Torque to approximately 7 in-lbs [79N-cm]). Do not over-tighten the screws.

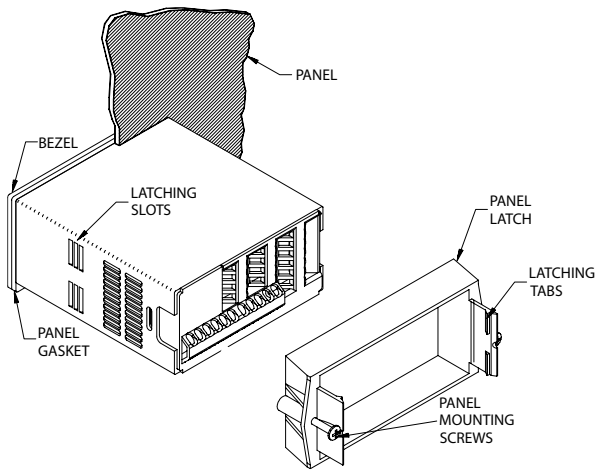

Installation Environment

The unit should be installed in a location that does not exceed the operating temperature and provides good air circulation. Placing the unit near devices that generate excessive heat should be avoided.

PANEL CUT-OUT

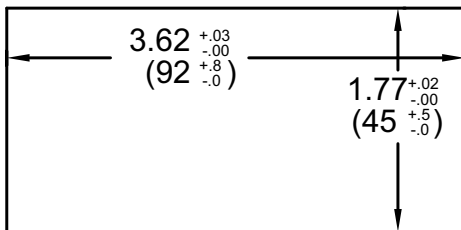

SETTING THE DIP SWITCHES

To access the switches, remove the meter base from the case by firmly squeezing and pulling back on the side rear finger tabs. This should lower the latch below the case slot (which is located just in front of the finger tabs). It is recommended to release the latch on one side, then start the other side latch.



Warning: Exposed line voltage exists on the circuit boards. Remove all power to the meter and load circuits before accessing inside of the meter.

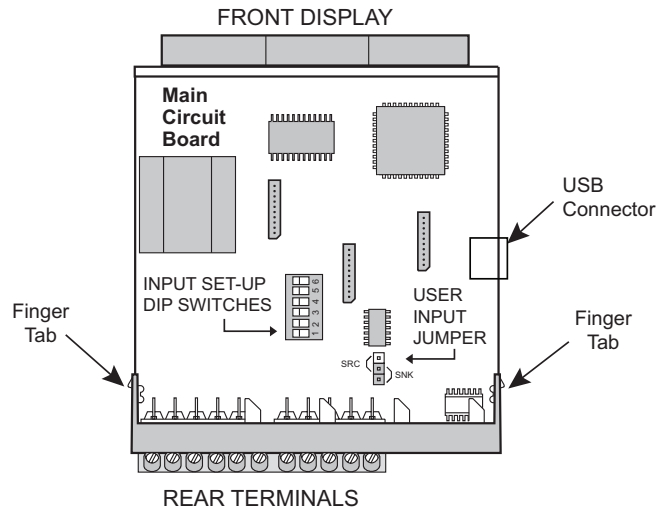

SETTING THE INPUT DIP SWITCHES

The meter has six DIP switches for Input A and Input B terminal set-up that must be set before applying power.

Input B LO Freq.	<input type="checkbox"/>	6	HI Freq.
Input B SRC.	<input type="checkbox"/>	5	SNK.
Input B MAG.	<input type="checkbox"/>	4	Logic
Input A LO Freq.	<input type="checkbox"/>	3	HI Freq.
Input A SRC.	<input type="checkbox"/>	2	SNK.
Input A MAG.	<input type="checkbox"/>	1	Logic
<input checked="" type="checkbox"/> Factory Setting			

SWITCHES 1 and 4

LOGIC: Input trigger levels $V_{IL} = 1.5 \text{ V max.}$; $V_{IH} = 3.75 \text{ V min.}$

MAG: 200 mV peak input sensitivity; 100 mV hysteresis; maximum voltage: $\pm 40 \text{ V peak (28 Vrms)}$; Input impedance: $3.9 \text{ K}\Omega @ 60 \text{ Hz}$; Must also have SRC switch ON. (Not recommended with counting applications.)

SWITCHES 2 and 5

SNK.: Adds internal $7.8 \text{ K}\Omega$ pull-up resistor to +5 VDC, $I_{MAX} = 0.7 \text{ mA}$.

SRC.: Adds internal $3.9 \text{ K}\Omega$ pull-down resistor, $7.3 \text{ mA max. @ 28 VDC}$, $V_{MAX} = 30 \text{ VDC}$.

SWITCHES 3 and 6

HI Frequency: Removes damping capacitor and allows max. frequency.

LO Frequency: Adds a damping capacitor for switch contact bounce. Also limits input frequency to maximum 50 Hz and input pulse widths to minimum 10 msec.

POWER WIRING

The power supplied to the meter shall employ a 15 Amp UL approved circuit breaker for AC input and a 1 Amp, 250 V UL approved fuse for DC input. It shall be easily accessible and marked as a disconnecting device to the installed unit. This device is not directly intended for connection to the mains without a reliable means to reduce transient over-voltages to 1500 V.

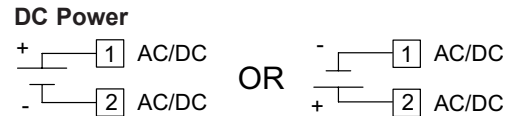
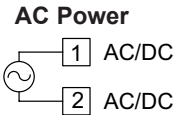

OR

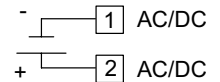

INPUT SIGNAL WIRING



CAUTION: Sensor input common is NOT isolated from user input common. In order to preserve the safety of the meter application, the sensor input common must be suitably isolated from hazardous live earth referenced voltage; or input common must be at protective earth ground potential. If not, hazardous voltage may be present at the User Inputs and User Input Common terminals. Appropriate considerations must then be given to the potential of the user input common with respect to earth ground; and the common of the isolated plug-in cards with respect to input common.

If you are wiring Input B, connect signal to Terminal 6 instead of 5, and set DIP switches 4, 5, and 6 to the positions shown for 1, 2, and 3.

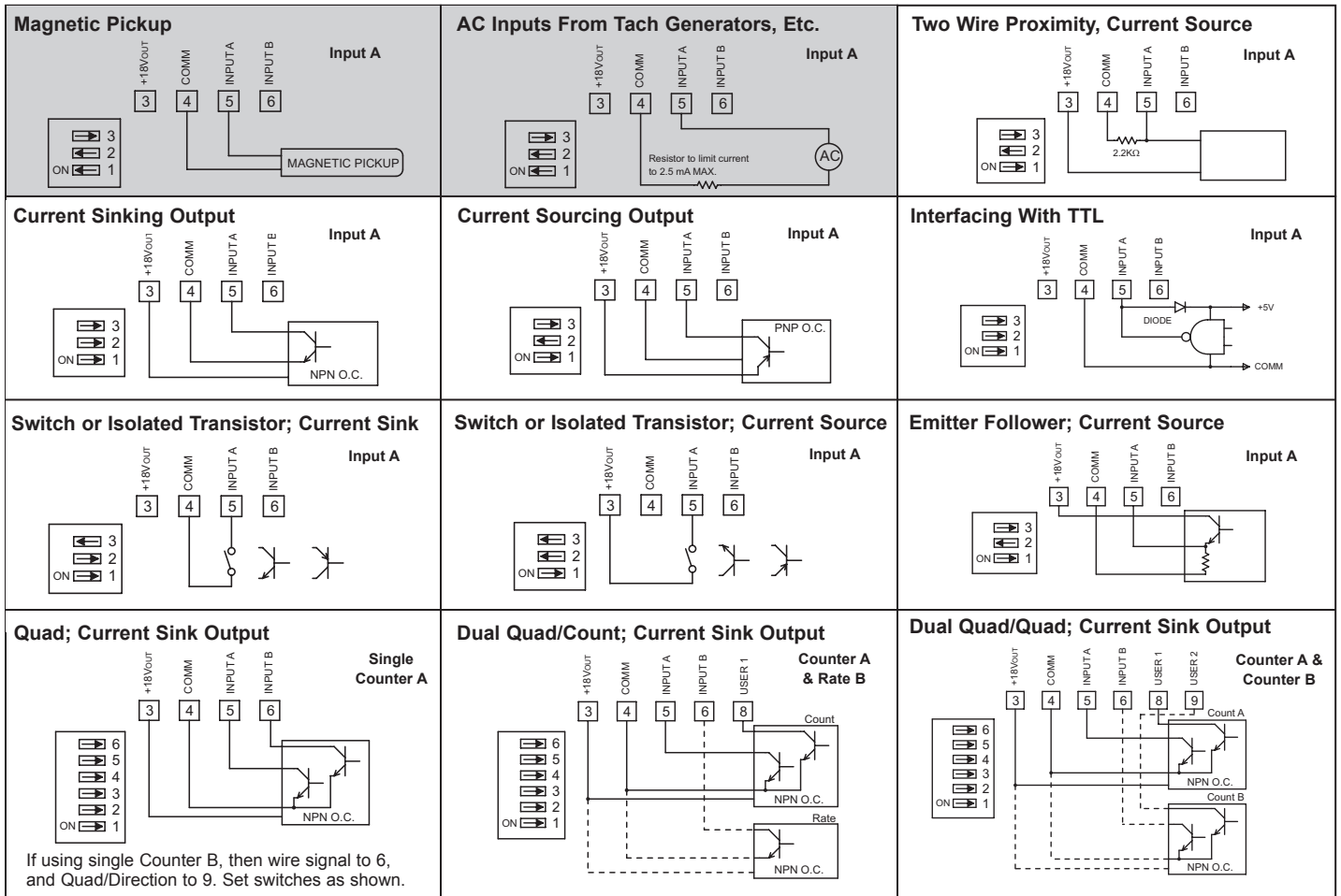

Shaded areas not recommended for counting applications.

USER INPUT WIRING

If User Input 1 and/or 2 are wired for quadrature or directional counting, an additional switching device should not be connected to that User Input terminal. User Input terminal does not need to be wired in order to remain in inactive state.

Sinking Logic ($USrAcLk = L0$)

When the $USrAcLk$ parameter is programmed to $L0$, the user inputs of the meter are internally pulled up to +3.3 V with 20 KΩ resistance. The input is active when it is pulled low (<1.1 V).

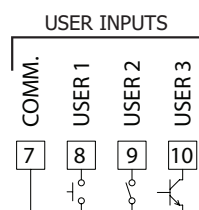

Sourcing Logic ($USrAcLk = H1$)

When the $USrAcLk$ parameter is programmed to $H1$, the user inputs of the meter are internally pulled down to 0 V with 20 KΩ resistance. The input is active when a voltage greater than 2.2 VDC is applied.

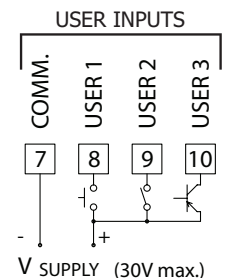

PRESCALER OUTPUT WIRING (NPN O.C.)

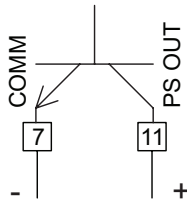

SETPOINT (ALARMS) WIRING
SERIAL COMMUNICATION WIRING
ANALOG OUTPUT WIRING

*See appropriate plug-in card
bulletin for wiring details.*

ORDERING INFORMATION

DESCRIPTION	PART NUMBER
Digital Input Panel Meter	PAX2D000
Dual Setpoint Relay Output Card	PAXCDS10
Quad Setpoint Relay Output Card	PAXCDS20
Quad Setpoint Sinking Open Collector Output Card	PAXCDS30
Quad Setpoint Sourcing Open Collector Output Card	PAXCDS40
RS485 Serial Communications Card with Terminal Block	PAXCDC10
Extended RS485 Serial Communications Card with Dual RJ11 Connector	PAXCDC1C
RS232 Serial Communications Card with Terminal Block	PAXCDC20
Extended RS232 Serial Communications Card with 9 Pin D Connector	PAXCDC2C
DeviceNet Communications Card	PAXCDC30
Profibus-DP Communications Card	PAXCDC50
Analog Output Card	PAXCDL10

LIMITED WARRANTY

The Company warrants the products it manufactures against defects in materials and workmanship for a period limited to two years from the date of shipment, provided the products have been stored, handled, installed, and used under proper conditions. The Company's liability under this limited warranty shall extend only to the repair or replacement of a defective product, at The Company's option. The Company disclaims all liability for any affirmation, promise or representation with respect to the products.

The customer agrees to hold Red Lion Controls harmless from, defend, and indemnify RLC against damages, claims, and expenses arising out of subsequent sales of RLC products or products containing components manufactured by RLC and based upon personal injuries, deaths, property damage, lost profits, and other matters which Buyer, its employees, or sub-contractors are or may be to any extent liable, including without limitation penalties imposed by the Consumer Product Safety Act (P.L. 92-573) and liability imposed upon any person pursuant to the Magnuson-Moss Warranty Act (P.L. 93-637), as now in effect or as amended hereafter.

No warranties expressed or implied are created with respect to The Company's products except those expressly contained herein. The Customer acknowledges the disclaimers and limitations contained herein and relies on no other warranties or affirmations.